

**DAEWOO**  
ELECTRONICS 0<<

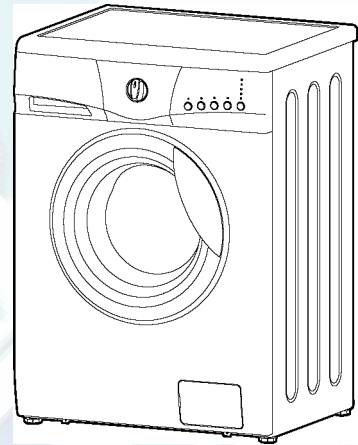

**DWD-M8021/8022/8023, DWD-M1021/1022/1023**



99,9% ( ) ,

|       |    |
|-------|----|
| ..... | 2  |
| ..... | 3  |
| ..... | 4  |
| ..... | 6  |
| ..... | 6  |
| ..... | 8  |
| ..... | 9  |
| ..... | 10 |
| ..... | 12 |
| ..... | 13 |
| ..... | 14 |
| ..... | 15 |
| ..... | 16 |

DAEWOO

DAEWOO.

**Примечание:**

Внешний вид устройства может варьироваться в зависимости от модели.

Данная иллюстрация отображает наличие различных функций у разных моделей стиральных машин.

Некоторые модели могут не содержать всех функций, указанных на иллюстрации.

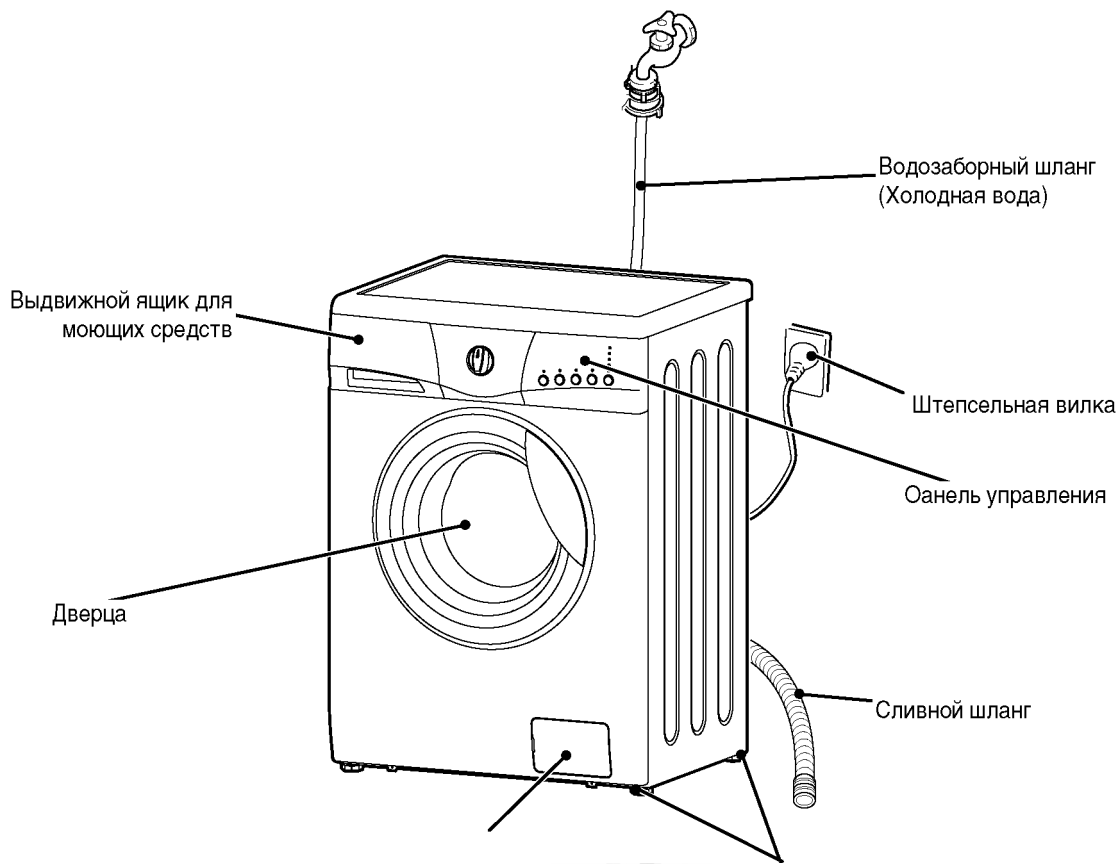

|                |  |         |     |
|----------------|--|---------|-----|
| ( -1<br>: 1 .) |  | ( 3 . ) | ( ) |
| 0)             |  |         |     |

---

( , , . )

.....

( , )

( )

1.

(3 .)

3.

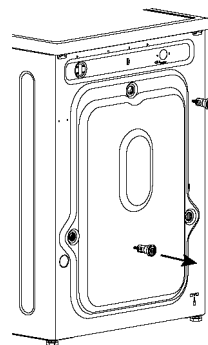

).

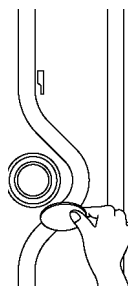

2.

3

10

00 .

2 )

(10 )

, 3

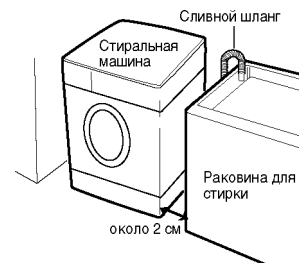

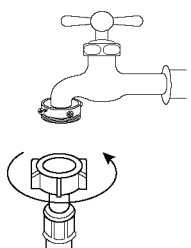
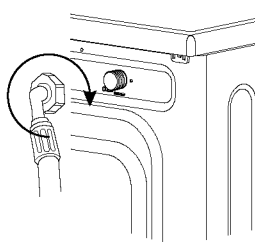
|   |  |
|---|--|
|  <p>1. Прочно подсоедините водозаборный шланг к крану.</p> |  <p>2. Прикрепите другой конец шланга к водозаборному клапану.</p> |
|---|--|

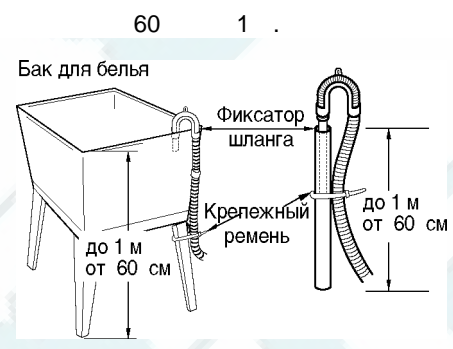
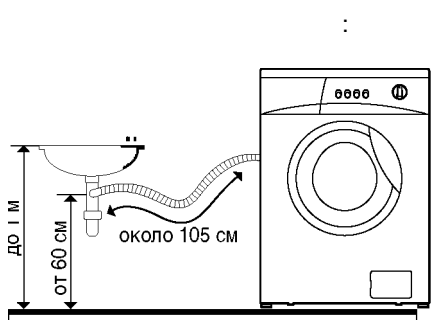

1



2



@

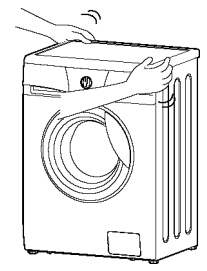

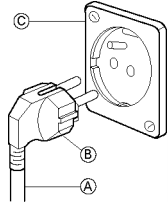

( . ). ( . )  
( . ).

|   |   |
|---|---|
| - | - |
|---|---|

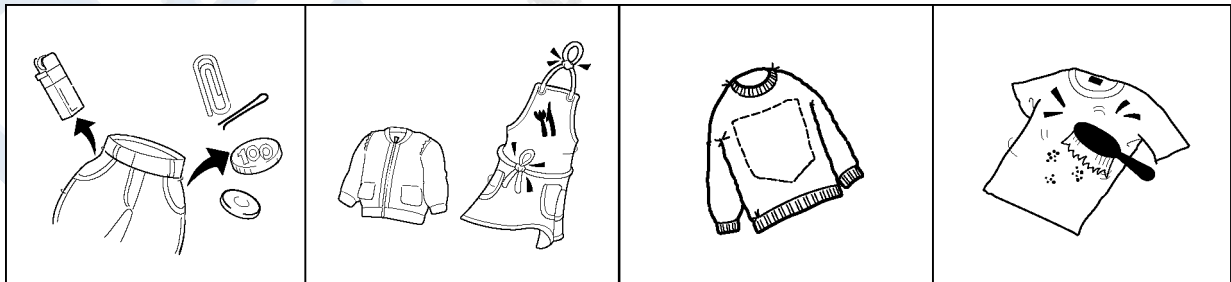



1

2

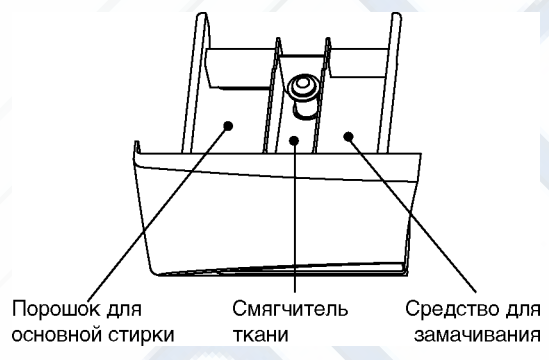

.( . . 13).

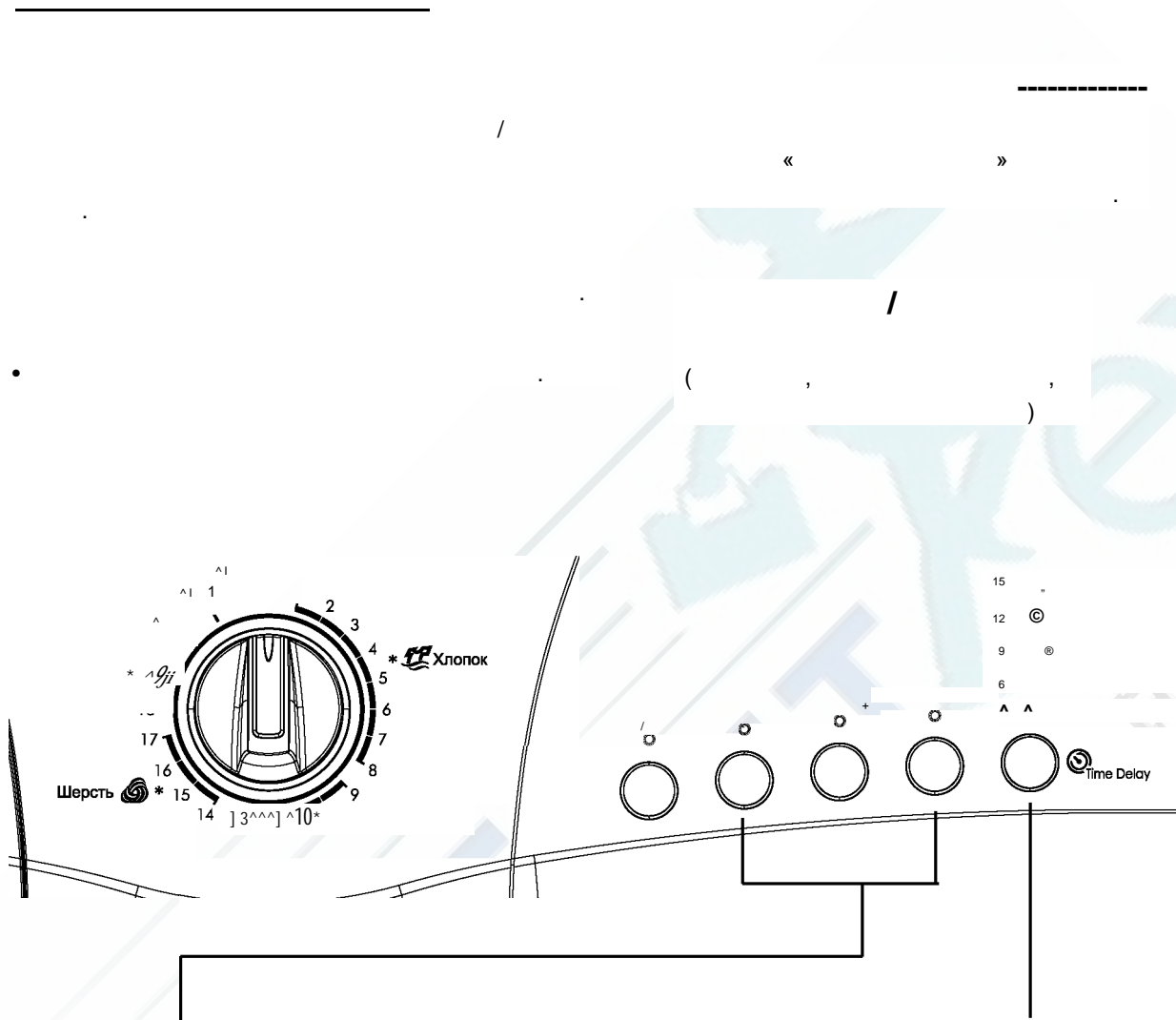

( )

+

« »

3 ^6 ^9  
^12 ^15  
- .^3



|    |         |                |  |   |     |  |
|----|---------|----------------|--|---|-----|--|
|    |         |                |  |   |     |  |
|    | ( , ^)  | 30<br>40       |  | + |     |  |
|    | ^ (     | 60             |  |   |     |  |
|    |         | 60 /           |  |   |     |  |
|    | , ^     | 95             |  |   |     |  |
| 30 |         | 30             |  | + | 1.0 |  |
|    | ( , ^)  | 30             |  | + | 2.5 |  |
|    | ( , )   | 30<br>40<br>60 |  | + | 2.5 |  |
|    |         | 60 /           |  |   |     |  |
|    | », «    | 30<br>40       |  | + | 1.0 |  |
|    | « »     | 30             |  | + |     |  |
|    | ( , _). | 30<br>40       |  | + | 1.0 |  |

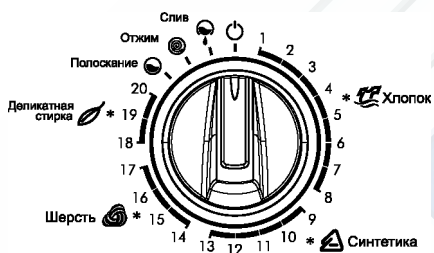

@ ©

/ (

^

®

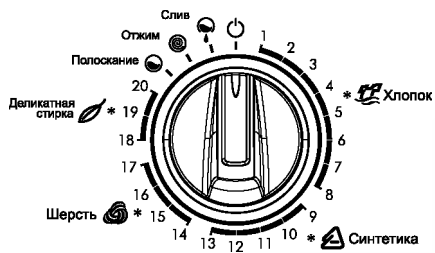

Off ( .),

@ @ ©  
/ % ++

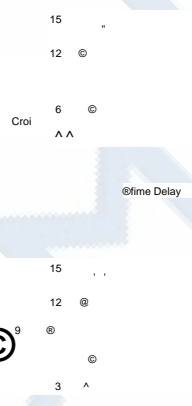

Off ( .).

Off ( .)



|                  |                  |
|------------------|------------------|
|                  |                  |
| -<br>-<br>-<br>- | -<br>-<br>-<br>- |

( )

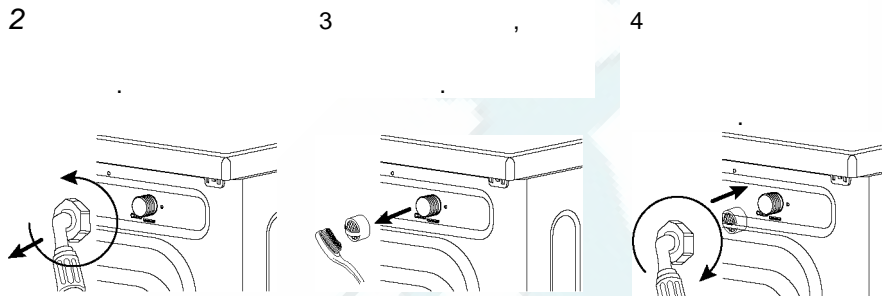

1. Откройте крышку (1) при помощи монетки. Снимите крышку (1).

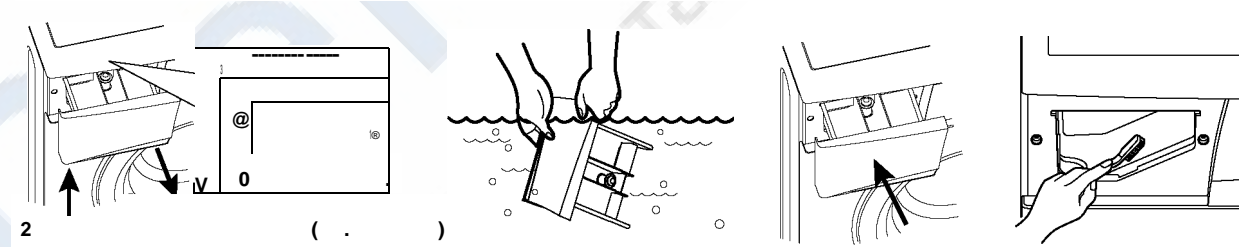
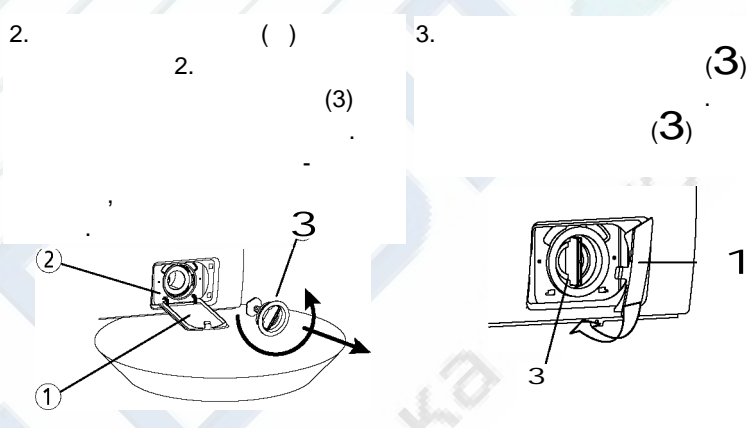
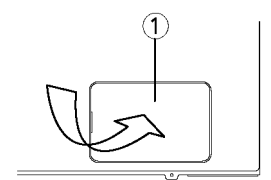

\_\_\_\_\_

( , , , , ).

■

-  
-  
-  
-  
-  
-

( . ).

|   |  |
|---|--|
|   |  |
|   |  |
|   |  |
|   |  |
|   |  |
| / |  |
|   |  |
|   |  |
|   |  |
|   |  |
|   |  |
|   |  |
|   |  |
|   |  |
|   |  |
|   |  |
|   |  |
|   |  |
|   |  |
|   |  |
|   |  |
|   |  |



|     | DWD-M8021/8022/8023                                 | DWD-M1021/1022/1023 |
|-----|---|---------------------|
| ( ) | 595 X 440 1 850 ( )                                 | 595 440 850 ( )     |
| ( ) | 54 ( )/57 ( )                                       |                     |
|     | 42  |                     |
| ( ) | 800   | 1000                |
|     | 0,03 ~ 0,8 (0,3 / <sup>2</sup> ~ 8 / <sup>2</sup> ) |                     |

